

TL3145 SERIES TACT SWITCH

ANTI-VANDAL SWITCHES
DETECTOR SWITCHES
DIP SWITCHES
KEYLOCK SWITCHES
NAVIGATION SWITCHES
PUSHBUTTON SWITCHES
ROCKER SWITCHES
ROTARY SWITCHES
SLIDE SWITCHES
SNAP ACTION SWITCHES
TACTILE SWITCHES
TOGGLE SWITCHES
CAP OPTIONS

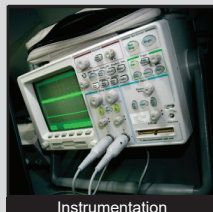

APPLICATIONS / MARKETS

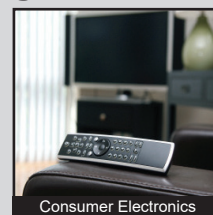
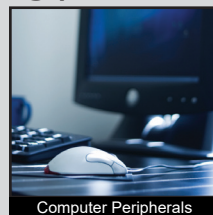
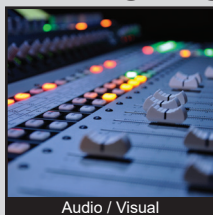

RoHS

SPECIFICATIONS

Electrical Rating: 50mA, 12VDC
Electrical Life: up to 3,000,000 Cycles
Contact Resistance: 100mΩ Max.
Insulation Resistance: 100MΩ Min. at 500VDC
Dielectric Strength: 250VAC for 1 Minute
Operating Temperature: -40°C to 85°C
Operating Force: 180gf ± 50gf (3,000,000 cycles)
 260gf ± 50gf (500,000 cycles)
 350gf ± 80gf (500,000 cycles)
Travel: 0.5mm
Dust/Moisture Protection: IP67
Function: SPST, Off-On

FEATURES & BENEFITS

- Up to 3,000,000 cycle life expectancy
- Tape and Reel packaging
- IP67 ratings
- Multiple force options

PART NUMBER CONFIGURATOR

Series	Circuit	Actuator	Force	Plating	Termination
TL	3145	A - 3.50 B - 5.20	F180 - 180 gf - White F260 - 260 gf - Red F350 - 350 gf - Orange	Q - Silver	J - J Lead

Specifications subject to change without notice 12.21.2020



E-SWITCH®

www.e-switch.com

800.867.2717

1

TL3145 SERIES TACT SWITCH

BODY DIMENSIONS

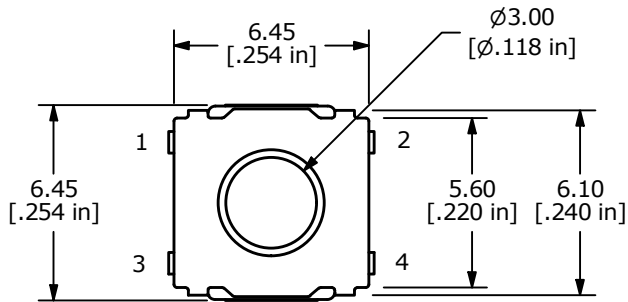
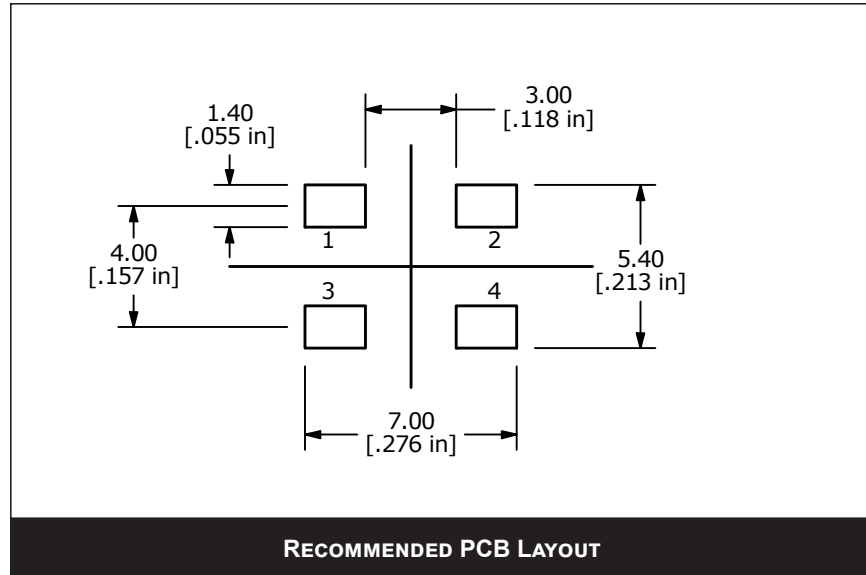
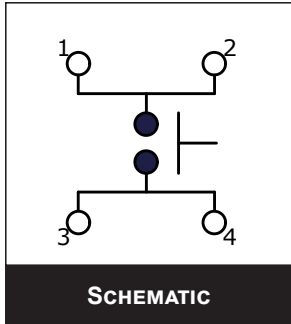

ACTUATOR	"X"
A	3.50
B	5.20

